

SP12CS

Quick Reference Guide

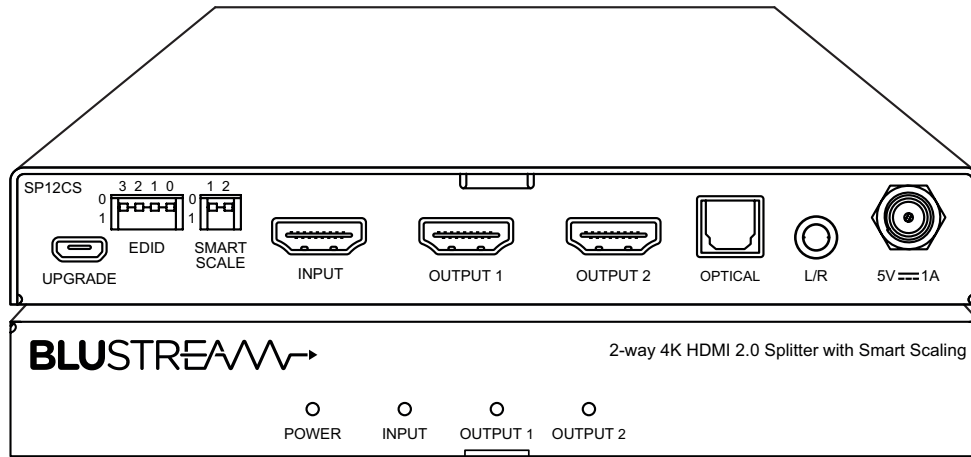

Introduction

Our SP12CS 4K HDMI 2.0b splitter distributes a single HDMI source to two simultaneous outputs with both digital (S/PDIF) and analogue audio breakout. The splitter supports full HDMI 2.0b and HDCP 2.2 with video resolutions up to and including 4K @ 60Hz 4:4:4 with automatic video down conversion on each output.

FEATURES:

- Features 1 x HDMI input that is replicated to 2 x HDMI outputs
- Supports HDMI 2.0b 18Gbps specification including HDR
- Supports up to 4K UHD 60Hz 4:4:4
- Video down-conversion (Smart Scale) on outputs allowing a display only capable of supporting lower video resolutions (4K 60Hz 4:2:0 or 1080p) to receive 4K 60Hz 4:4:4 video content while still showing maximum original 4K UHD resolution on remaining video outputs
- Supports all industry standard video resolutions including VGA-WUXGA and 480i-4K
- Supports all known HDMI audio formats including Dolby Atmos, Dolby TrueHD, Dolby Digital Plus and DTS-HD Master Audio transmission
- HDMI audio breakout to analogue L/R audio and optical (S/PDIF) digital outputs concurrently
- Advanced EDID management
- HDCP 2.2 compliant

Front Panel Description

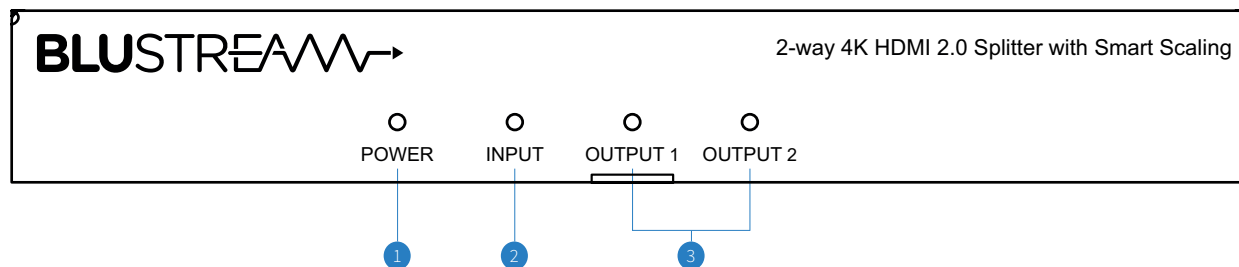

- ① Power LED - indicates if SP12CS is on or off
- ② Input LED - indicates if HDMI input is active
- ③ Output LED - indicates if HDMI output is active

Rear Panel Description

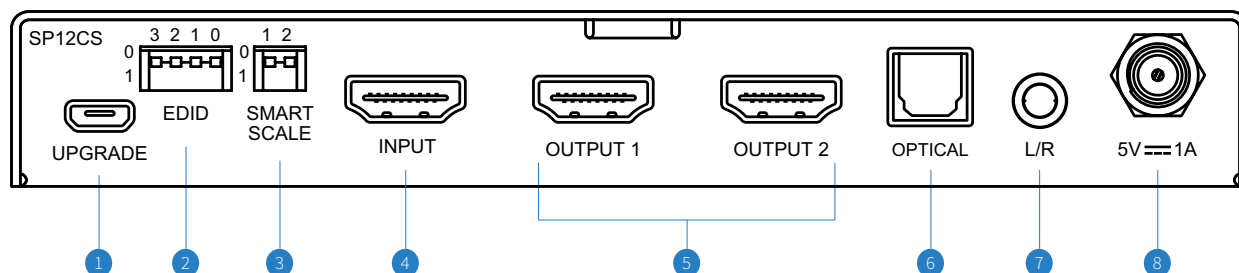

- ① Update - Micro USB connector for updating the splitter firmware or for software control of EDID's
- ② EDID DIP switch – Used for input EDID settings
- ③ Smart Scale DIP switch – Used for changing the scaling options per HDMI output
- ④ HDMI Input - Connect to source device
- ⑤ HDMI Outputs - Connect to display devices
- ⑥ Digital Audio Output - Optical (S/PDIF)
- ⑦ Analogue L/R Audio Output - 3.5mm stereo connector with fixed line level output. Supports 2 channel PCM audio formats only
- ⑧ Power Port - Use included 5V/1A DC power adaptor

EDID Control

EDID (Extended Display Identification Data) is a data structure that is used between a display and a source. This data is used by the source to find out what audio and video resolutions are supported by the display/s. By pre-determining the video resolution and audio format of the source and display devices, you can reduce the time needed for EDID hand shaking thus making power cycles quicker and more reliable.

Configuration of the EDID settings for the input can be achieved either via the EDID DIP switches on the rear of the splitter, or by using the micro-USB connector and Blustream EDID API commands.

EDID DIP Switches

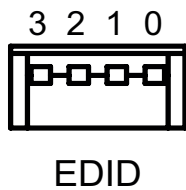

EDID DIP Switches:

- [DIP]=0000: HDMI 4K@60Hz 4:4:4, 12-bit HDR, Audio 2ch PCM
- [DIP]=0001: HDMI 4K@60Hz 4:4:4, 12-bit HDR, Audio 5.1ch DTS/DOLBY
- [DIP]=0010: HDMI 4K@60Hz 4:4:4, 12-bit HDR, Audio 7.1ch DTS/DOLBY/HD
- [DIP]=0011: HDMI 4K@60Hz 4:4:4, 10-bit HDR, Audio 2ch PCM
- [DIP]=0100: HDMI 4K@60Hz 4:4:4, 10-bit HDR, Audio 5.1ch DTS/DOLBY
- [DIP]=0101: HDMI 4K@60Hz 4:4:4, 10-bit HDR, Audio 7.1ch DTS/DOLBY/HD
- [DIP]=0110: HDMI 4K@60Hz 4:2:0 / 4K@30Hz 4:4:4, Audio 2ch PCM
- [DIP]=0111: HDMI 4K@60Hz 4:2:0 / 4K@30Hz 4:4:4, Audio 5.1ch DTS/DOLBY
- [DIP]=1000: HDMI 4K@60Hz 4:2:0 / 4K@30Hz 4:4:4, Audio 7.1ch DTS/DOLBY/HD
- [DIP]=1001: HDMI 1080p@60Hz, Audio 2ch PCM
- [DIP]=1010: HDMI 1080p@60Hz, Audio 5.1ch DTS/DOLBY
- [DIP]=1011: HDMI 1080p@60Hz, Audio 7.1ch DTS/DOLBY/HD
- [DIP]=1100: DVI 1920x1080@60Hz, Audio None
- [DIP]=1101: DVI 1920x1200@60Hz, Audio None
- [DIP]=1110: Software Control EDID (use USB to serial adaptor and API to adjust)
- [DIP]=1111: EDID Bypass (Copy EDID of Output 1)

Smart Scale Control

The SP12CS has a Smart Scale feature on each output, allowing a display only capable of supporting lower video resolutions (4K 60Hz 4:2:0, or 1080p) to receive down-scaled 4K video content (up to 4K 60Hz 4:4:4), while still showing the maximum original 4K UHD resolution on the other output.

The SP12CS default mode is AUTO (both Smart Scale DIP switches pointing UP), this mode will automatically negotiate the best output video resolution suitable for the connected display. If the Scaler mode is set to bypass, the video output will match the source input signal.

Smart Scale DIP Switches

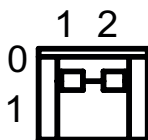

Smart Scale DIP Switches

- [DIP]=1: HDMI Output 1
- [DIP]=2: HDMI Output 2

Smart Scale Modes

- [DIP]=UP: Auto Smart Scale
- [DIP]=Down: Smart Scale Bypass / Force 1080p (see below)

Should the auto-negotiation not produce the desired result, the SP12CS has the ability to force the down-scaler to output 1080p on individual outputs - this replaces the BYPASS scaling option. To change the scaling mode either change the mode via API command, or after power cycle complete the following sequence of changes to Smart Scale DIP switch '1' (the left switch):

00 > 10 > 00 > 10 > 00 > 10 > 00

On completion of the sequence above, the input LED's will flash. Select the outputs that need to be forced to 1080p by setting the Smart Scale DIP switch/es to 'DOWN'. The video output will now be fixed to 1080p. To revert this setting, simply put the DIP switch back to the UP position.

Specifications

- **Video Input Connectors:** 1 x HDMI Type A
- **Video Output Connectors:** 2 x HDMI Type A
- **EDID:** 4-pin DIP switch
- **Smart Scale:** 2-pin DIP switch
- **RS-232 Serial Port:** 1 x Micro USB Connector
- **Audio Output Connectors:** 1 x Digital (Optical), 1x Analogue audio L/R (3.5mm stereo jack)
- **Dimensions (W x D x H):** 158mm x 64mm x 23mm, without feet
- **Shipping Weight:** 0.7g
- **Operating Temperature:** 32°F to 104°F (0°C to 40°C)
- **Storage Temperature :** -4°F to 140°F (-20°C to 60°C)
- **Power Supply:** 5V/1A DC

Package Contents

- 1 x SP12CS
- 1 x 5V/1A DC power supply
- 1 x Mounting kit
- 1 x Quick reference guide

NOTE: Specifications are subject to change without notice. Weights and dimensions are approximate.

Certifications

FCC NOTICE

This equipment has been tested and found to comply with the limits for a Class B digital device, pursuant to part 15 of the FCC Rules. These limits are designed to provide reasonable protection against harmful interference in a residential installation. This equipment generates, uses, and can radiate radio frequency energy and, if not installed and used in accordance with the instructions, may cause harmful interference to radio communications. However, there is no guarantee that interference will not occur in a particular installation. If this equipment does cause harmful interference to radio or television reception, which can be determined by turning the equipment off and on, the user is encouraged to try to correct the interference by one or more of the following measures:

- Reorient or relocate the receiving antenna.
- Increase the separation between the equipment and receiver.
- Connect the equipment into an outlet on a circuit different from that to which the receiver is connected.
- Consult the dealer or an experienced radio/TV technician for help.

CAUTION - changes or modifications not expressly approved by the party responsible for compliance could void the user's authority to operate the equipment.

CANADA, INDUSTRY CANADA (IC) NOTICES

This Class B digital apparatus complies with Canadian ICES-003.

Operation is subject to the following two conditions: (1) this device may not cause interference, and (2) this device must accept any interference, including interference that may cause undesired operation of the device.

CORRECT DISPOSAL OF THIS PRODUCT

This marking indicates that this product should not be disposed with other household wastes. To prevent possible harm to the environment or human health from uncontrolled waste disposal, recycle it responsibly to promote the sustainable reuse of material resources. To return your used device, please use the return and collection systems or contact the retailer where the product was purchased. They can take this product for environmentally safe recycling.

SP14CS

Quick Reference Guide

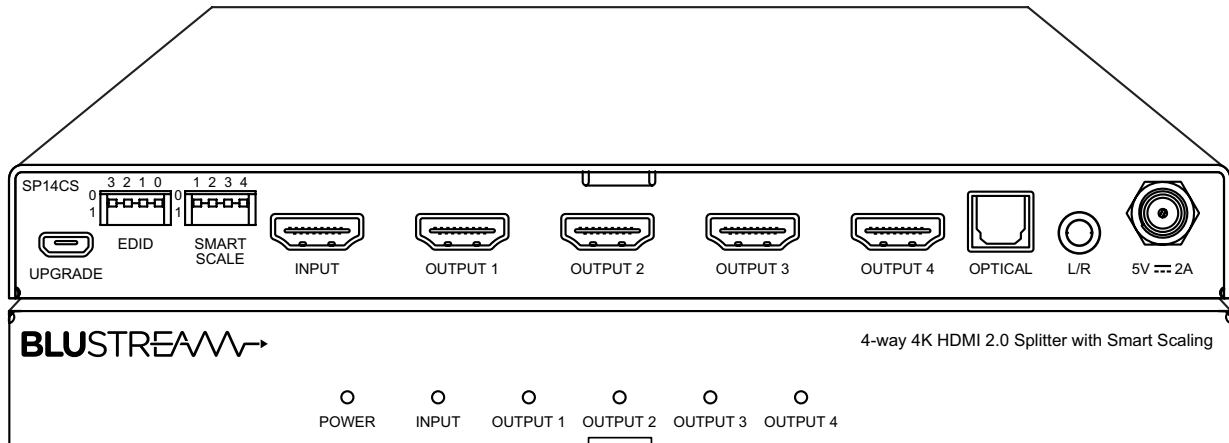

Introduction

Our SP14CS 4K HDMI 2.0b splitter distributes a single HDMI source to four simultaneous outputs with both digital (S/PDIF) and analogue audio breakout. The splitter supports full HDMI 2.0b and HDCP 2.2 with video resolutions up to and including 4K @ 60Hz 4:4:4 with automatic video down conversion on each output.

FEATURES:

- Features 1 x HDMI input that is replicated to 4 x HDMI outputs
- Supports HDMI 2.0b 18Gbps specification including HDR
- Supports up to 4K UHD 60Hz 4:4:4
- Video down-conversion (Smart Scale) on outputs allowing a display only capable of supporting lower video resolutions (4K 60Hz 4:2:0 or 1080p) to receive 4K 60Hz 4:4:4 video content while still showing maximum original 4K UHD resolution on remaining video outputs
- Supports all industry standard video resolutions including VGA-WUXGA and 480i-4K
- Supports all known HDMI audio formats including Dolby Atmos, Dolby TrueHD, Dolby Digital Plus and DTS-HD Master Audio transmission
- HDMI audio breakout to analogue L/R audio and optical (S/PDIF) digital outputs concurrently
- Advanced EDID management
- HDCP 2.2 compliant

Front Panel Description

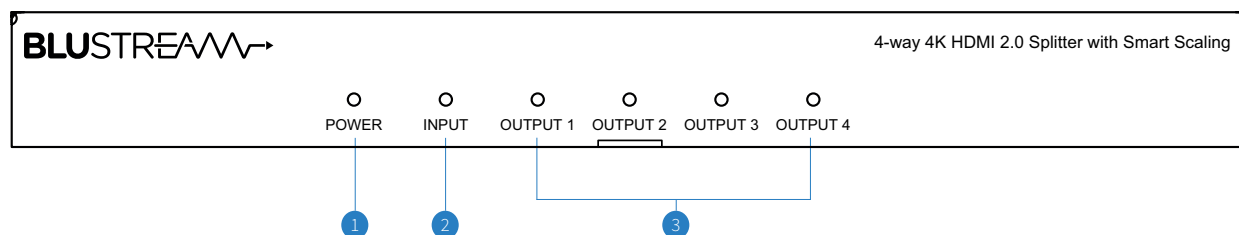

- ① Power LED - indicates if SP14CS is on or off
- ② Input LED - indicates if HDMI input is active
- ③ Output LED - indicates if HDMI output is active

Rear Panel Description

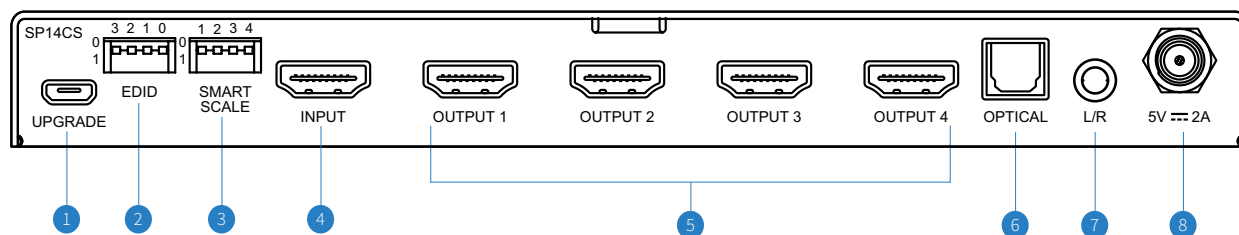

- ① Update - Micro USB connector for updating the splitter firmware or for software control of EDID's
- ② EDID DIP switch – Used for input EDID settings
- ③ Smart Scale DIP switch – Used for changing the scaling options per HDMI output
- ④ HDMI Input - Connect to source device
- ⑤ HDMI Outputs - Connect to display devices
- ⑥ Digital Audio Output - Optical (S/PDIF)
- ⑦ Analogue L/R Audio Output - 3.5mm stereo connector with fixed line level output. Supports 2 channel PCM audio formats only
- ⑧ Power Port - Use included 5V/1A DC power adaptor

EDID Control

EDID (Extended Display Identification Data) is a data structure that is used between a display and a source. This data is used by the source to find out what audio and video resolutions are supported by the display/s. By pre-determining the video resolution and audio format of the source and display devices, you can reduce the time needed for EDID hand shaking thus making power cycles quicker and more reliable.

Configuration of the EDID settings for the input can be achieved either via the EDID DIP switches on the rear of the splitter, or by using the micro-USB connector and Blustream EDID API commands.

EDID Dip switches

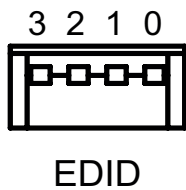

EDID Dip switches

- [DIP]=0000: HDMI 4K@60Hz 4:4:4, 12-bit HDR, Audio 2ch PCM
- [DIP]=0001: HDMI 4K@60Hz 4:4:4, 12-bit HDR, Audio 5.1ch DTS/DOLBY
- [DIP]=0010: HDMI 4K@60Hz 4:4:4, 12-bit HDR, Audio 7.1ch DTS/DOLBY/HD
- [DIP]=0011: HDMI 4K@60Hz 4:4:4, 10-bit HDR, Audio 2ch PCM
- [DIP]=0100: HDMI 4K@60Hz 4:4:4, 10-bit HDR, Audio 5.1ch DTS/DOLBY
- [DIP]=0101: HDMI 4K@60Hz 4:4:4, 10-bit HDR, Audio 7.1ch DTS/DOLBY/HD
- [DIP]=0110: HDMI 4K@60Hz 4:2:0 / 4K@30Hz 4:4:4, Audio 2ch PCM
- [DIP]=0111: HDMI 4K@60Hz 4:2:0 / 4K@30Hz 4:4:4, Audio 5.1ch DTS/DOLBY
- [DIP]=1000: HDMI 4K@60Hz 4:2:0 / 4K@30Hz 4:4:4, Audio 7.1ch DTS/DOLBY/HD
- [DIP]=1001: HDMI 1080p@60Hz, Audio 2ch PCM
- [DIP]=1010: HDMI 1080p@60Hz, Audio 5.1ch DTS/DOLBY
- [DIP]=1011: HDMI 1080p@60Hz, Audio 7.1ch DTS/DOLBY/HD
- [DIP]=1100: DVI 1920x1080@60Hz, Audio None
- [DIP]=1101: DVI 1920x1200@60Hz, Audio None
- [DIP]=1110: Software Control EDID (use API to adjust)
- [DIP]=1111: EDID Bypass

Smart Scale Control

The SP14CS has a Smart Scale feature on each output, allowing a display only capable of supporting lower video resolutions (4K 60Hz 4:2:0, or 1080p) to receive down-scaled 4K video content (up to 4K 60Hz 4:4:4), while still showing the maximum original 4K UHD resolution on other outputs.

The SP14CS default mode is AUTO (Smart Scale DIP switches pointing UP), this mode will automatically negotiate the best output video resolution suitable for the connected display. If the Scaler mode is set to bypass, the video output will match the source input signal.

Smart Scale DIP Switches

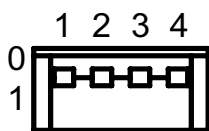

Smart Scale DIP Switches

- [DIP]=1: HDMI Output 1
- [DIP]=2: HDMI Output 2
- [DIP]=3: HDMI Output 3
- [DIP]=4: HDMI Output 4

Smart Scale Modes

- [DIP]=UP: Auto Smart Scale
- [DIP]=Down: Smart Scale Bypass / Force 1080p (see below)

Should the auto-negotiation not produce the desired result, the SP14CS has the ability to force the down-scaler to output 1080p on individual outputs - this replaces the BYPASS scaling option. To change the scaling mode either change the mode via API command, or after power cycle complete the following sequence of changes to Smart Scale DIP switch '1' (the left switch):

0000 > 1000 > 0000 > 1000 > 0000 > 1000 > 0000

On completion of the sequence above, the input LED's will flash. Select the outputs that need to be forced to 1080p by setting the Smart Scale DIP switch/es to 'DOWN'. The video output will now be fixed to 1080p. To revert this setting, simply put the DIP switch back to the UP position.

Specifications

- **Video Input Connectors:** 1 x HDMI Type A, 19-pin, female
- **Video Output Connectors:** 4 x HDMI Type A, 19-pin, female
- **Audio Output Connectors:** 1 x Optical (S/PDIF), 1 x Analogue audio L/R (3.5mm stereo Jack)
- **EDID:** 1 x 4-pin DIP switch
- **Smart Scale:** 1 x 4-pin DIP switch
- **RS-232 Serial Port:** 1 x Micro USB connector
- **Dimensions (W x H x D):** 203mm x 84mm x 23mm
- **Shipping Weight:** 0.8kg
- **Operating Temperature:** 32°F to 104°F (0°C to +40°C)
- **Storage Temperature:** -4°F to 140°F (-20°C to +60°C)
- **Power Supply:** 5V/2A DC screw terminal

Package Contents

- 1 x SP14CS
- 1 x 5V/2A DC power supply
- 1 x Mounting kit
- 1 x Quick reference guide

NOTE: Specifications are subject to change without notice. Weights and dimensions are approximate.

Certifications

FCC NOTICE

This equipment has been tested and found to comply with the limits for a Class B digital device, pursuant to part 15 of the FCC Rules. These limits are designed to provide reasonable protection against harmful interference in a residential installation. This equipment generates, uses, and can radiate radio frequency energy and, if not installed and used in accordance with the instructions, may cause harmful interference to radio communications. However, there is no guarantee that interference will not occur in a particular installation. If this equipment does cause harmful interference to radio or television reception, which can be determined by turning the equipment off and on, the user is encouraged to try to correct the interference by one or more of the following measures:

- Reorient or relocate the receiving antenna.
- Increase the separation between the equipment and receiver.
- Connect the equipment into an outlet on a circuit different from that to which the receiver is connected.
- Consult the dealer or an experienced radio/TV technician for help.

CAUTION - changes or modifications not expressly approved by the party responsible for compliance could void the user's authority to operate the equipment.

CANADA, INDUSTRY CANADA (IC) NOTICES

This Class B digital apparatus complies with Canadian ICES-003.

Operation is subject to the following two conditions: (1) this device may not cause interference, and (2) this device must accept any interference, including interference that may cause undesired operation of the device.

CORRECT DISPOSAL OF THIS PRODUCT

This marking indicates that this product should not be disposed with other household wastes. To prevent possible harm to the environment or human health from uncontrolled waste disposal, recycle it responsibly to promote the sustainable reuse of material resources. To return your used device, please use the return and collection systems or contact the retailer where the product was purchased. They can take this product for environmentally safe recycling.